

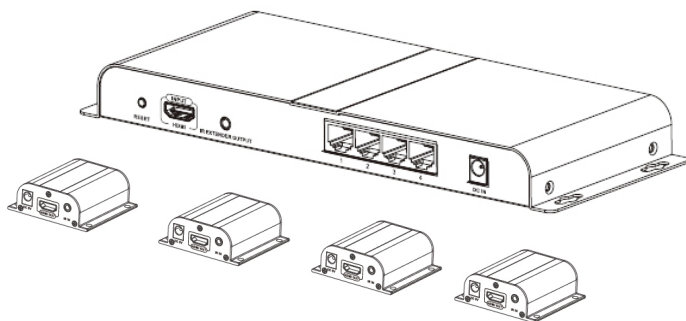

4-Port HDMI HDbiT Extender 1080p - 120m User's Guide



P/N:HDbiT4P

Thank you for purchasing from gofanco. Our products aim to meet all your connectivity needs wherever you go. For optimum performance and safety, please read the instructions carefully and keep this User's Guide for future reference. If you need more information about our products, please visit www.gofanco.com. For technical support, email us at support@gofanco.com. For drivers/manuals download, please go to <http://www.gofanco.com/download>.

Important Safety Notices

Please read safety instructions carefully before installation and operation.

- Please pay close attention to all warnings and hints for this device
- Do not expose this unit to rain, heavy moisture, or liquid
- Do not put any items into the device or attempt to modify its operation
- Do not repair the device or open the enclosure without professional guidance to avoid electric shocks. Doing so may void your warranty
- Keep the product in a well-ventilated location to avoid damage from overheating
- Shut off power and make sure environment is safe before installation
- Do not plug the HDMI cables and IR cables in/out when the device is in use to avoid cable damage. Make sure they are plugged into the correct ports
- Use the included power adapters only. Make sure the specification matches if using 3rd-party DC power adapters

Introduction

The 4-Port HDMI HDBitT Extender 1080p - 120m extends high definition 1080p signals up to 394ft (120m) over CAT6 to 4 monitors.

Package Contents

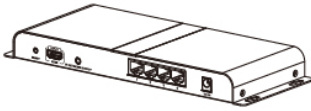

Transmitter (1pc)



Receiver (4pcs)

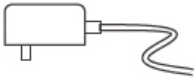

Power Adapter
5V/2A (1pc)

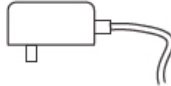

Power Adapter
5V/1A (4pcs)



Manual (1pc)



IR Blaster Cable (1pc)



IR Receiver Cable (4pcs)

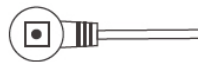

Product Layout

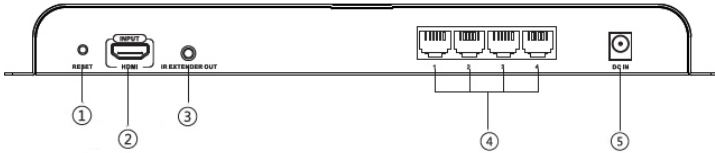

Figure 1: Transmitter (TX) - Back Panel

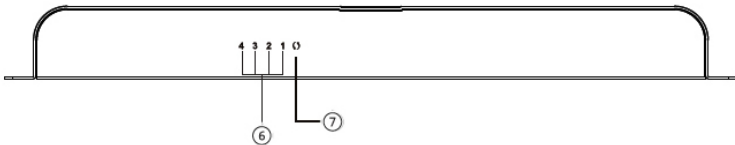

Figure 2: Transmitter (TX) - Front Panel

- 1 **Reset:** Press to reset the Transmitter
- 2 **HDMI In:** Connects to the HDMI source device
- 3 **IR Out:** Infrared 3.5mm socket. Plug the IR Blaster Cable here. See instructions on page 7.
- 4 **RJ45 Out (x4):** Connects to the Receiver's RJ45 In using a Cat6 cable
- 5 **Power Jack:** Connect the included 5V/2A power adapter here
- 6 **Link LED (x4):** Lights up when RJ45 signal is detected
- 7 **Data LED:** Blinks when data transfer is detected

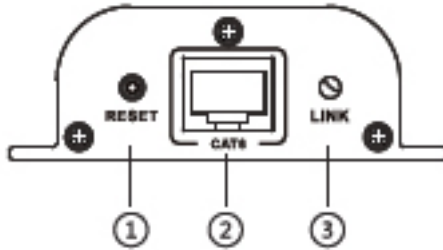

Figure 3: Receiver (RX) - Input

- 1 **Reset:** Press to reset if the HDMI Extender doesn't work properly
- 2 **RJ45 In:** Link to the Transmitter's RJ45 Out via Cat6 cable
- 3 **Link LED:** Blinks when powered on. On when the Cat6 cable is connected/linked properly between the Transmitter and Receiver

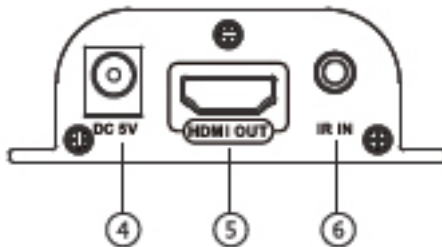

Figure 4: Receiver (RX) - HDMI Output

- 4 **Power Jack:** Connect the included 5V/1A power adapter here
- 5 **HDMI Out:** Connect your HDMI display here with an HDMI cable (cable not included)
- 6 **IR In:** Infrared 3.5mm socket. Plug IR Receiver Cable here. See instructions on page 7.

Installation Requirements

1. HDMI source device (DVD player, set top box, PC, etc.)
2. HDMI display device (SDTV/Monitor, HDTV/Monitor, projector, etc.)
3. HDMI cables (not included)
4. UTP/STP CAT6/6A/7 cable, following IEEE-568B wiring standard

Cat Cable Wiring

We suggest both RJ45 connectors be wired identically using T568B wiring standard for the best performance and compatibility.

Both connectors must be wired identically, to T568B standard.

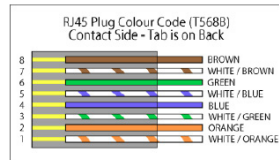
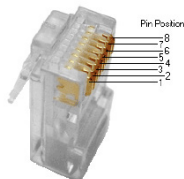

Note: You may use cat5e, cat6 UTP (cat6 preferred) in conjunction with the HDBiT output; however for best performance use cat6a or cat7 (particularly in electrically noisy environments). The maximum distances & transmission performance for HDMI and HDBT may be compromised by cable quality, patch panels, poor termination, wall plates, cable kinks and electrical interferences. Generally ensure the cat cable is solid copper core of 23AWG (avoid CCA type), in one straight run (avoid/minimise patches) and avoid close proximity to any noisy electrical sources.

Hardware Installation

To achieve optimal performance, Cat6 cable is recommended.

1. Power off all devices including your HDMI source and HDMI display.
2. Connect your HDMI source to the Transmitter's HDMI In connector.
3. Optional: Connect the IR Blaster Cable to the Transmitter's IR Out port. Face the eye towards your HDMI source device's IR window. This connection is needed only if you need to control your HDMI source at the remote location.
4. Plug your Cat6 cable between the Transmitter's RJ45 Out and Receiver's RJ45 In.
5. Connect your HDMI display to the Receiver's HDMI Out connector with an HDMI cable (HDMI cable not included).
6. Optional: Connect the IR Receiver Cable to the Receiver's IR In port. This connection is needed only if you need to control your HDMI source at the remote location.
7. Plug the included 5V/2A power adapter into the Transmitter's Power Jack.
8. Plug the included 5V/1A power adapter into the Receiver's Power Jack, then plug all power adapters into reliable power outlets.
9. Power on your HDMI source device and HDMI displays. The extender is ready for use.

Connection Diagram

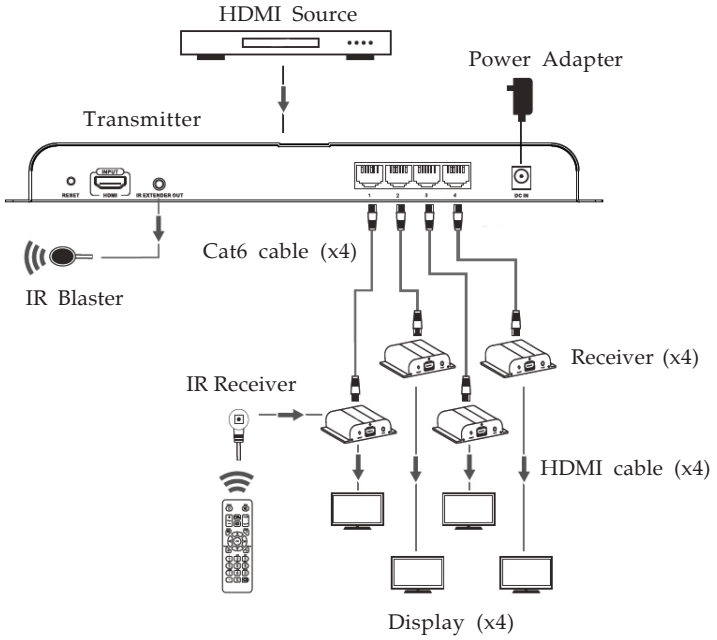

FAQ & Solutions

Q1: No image or audio output on the display?

- A:
1. Check if the display is in standby mode.
 2. Make sure the display's HDMI port is properly connected to the HDMI cable.
 3. Check the Link LED indicator on the Receiver is on.

Q2: Not all displays are receiving a signal.

- A:
1. Check the Cat6 cables for secure and solid connection.
 2. Press the Reset button on the Transmitter and Receiver to reset the system.
 3. Re-connect the Cat6 cable(s) corresponding to the display(s) that are not working properly.

Q3: TV displays "Waiting for Connection" on the bottom right corner.

- A:
1. Check the Cat6 cables for secure and solid connection.
 2. Check the power supply on both transmitter and receiver(s) is connected and powered on.

Q4: TV displays "Please check the TX input signal".

- A:
1. Please check the HDMI cable is connected properly and the HDMI source device is powered on.
 2. Press the reset button on the Transmitter.
 3. Connect the TV directly to the HDMI source device to verify there is signal output.

Specifications

Item	Specification
HDMI signal	HDMI 1.3, HDCP 1.4
Input	TX: 1x, 19-pin HDMI, Female RX: 1x, RJ45; 1x, IR, 3.5mm socket
Output	TX: 4x, RJ45; 1x, IR, 3.5mm socket RX: 1x, 19-pin HDMI, Female
Resolution	480i@60Hz, 480p@60Hz, 576i@50Hz, 576p@50Hz, 720p@50/60Hz, 1080i@50/60Hz, 1080p@50/60Hz
Transmission distance	Up to 394 ft (120m)
IR signal	20KHz - 60KHz
Operating temperature	32 F - 140 F (0 - 60 C)
Power adapter	TX: 5VDC/2A RX: 5VDC/1A

Disclaimer

The product name and brand name may be registered trademarks of related manufacturers. TM and ® may be omitted on the user's guide. The pictures on the user's guide are just for reference, and there may be some slight differences with the actual products.

We reserve the rights to make changes without prior notice to a product or system described herein to improve reliability, function, or design.



Thank you for choosing gofanco

www.gofanco.com